

FEATURES

- Ideal for Electron Detection
- Large Detection Area
- Protective Cover Plate³

Electro-Optical Characteristics at 25 °C

Parameters	Test Conditions	Min	Typ	Max	Units
Active Area	10 mm x 10 mm		100		mm ²
Responsivity	(see graph on next page)	0.07	0.08	0.09	A/W
Shunt Resistance, Rsh	V _B = ± 10 mV	20			M-ohm
Reverse Breakdown Voltage, V _R	I _R = 1 µA	5	10		Volts
Capacitance, C	V _R = 0 V		5	15	nF
Rise Time	V _R = 0 V, R _L = 50 Ω			10	usec

Thermal Parameters

Storage and Operating Temperature Range	Units
Ambient ¹	-10 ° to 40 °C
Nitrogen or Vacuum	-20 °C to 80 °C
Lead Soldering Temperature ²	260 °C

¹ Temperatures exceeding these parameters may create oxide growth on the active area. Over time responsivity to low energy radiation and wavelengths below 150 nm will be compromised.

² 0.080" from case for 10 seconds.

³ Shipped with temporary cover to protect the photodiode array and wire bonds. Review the Application Note, "Handling Precautions for AXUV, SXUV, and UVG Detectors", prior to removing cover.

Typical Electron Response

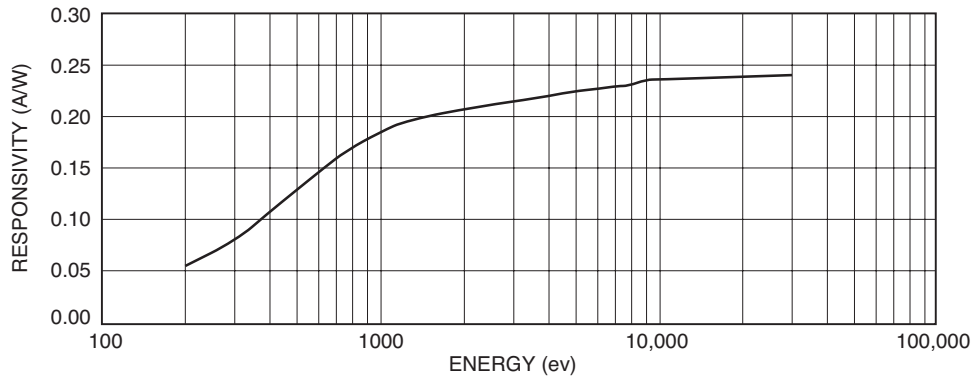

Typical EUV-UV Photon Response

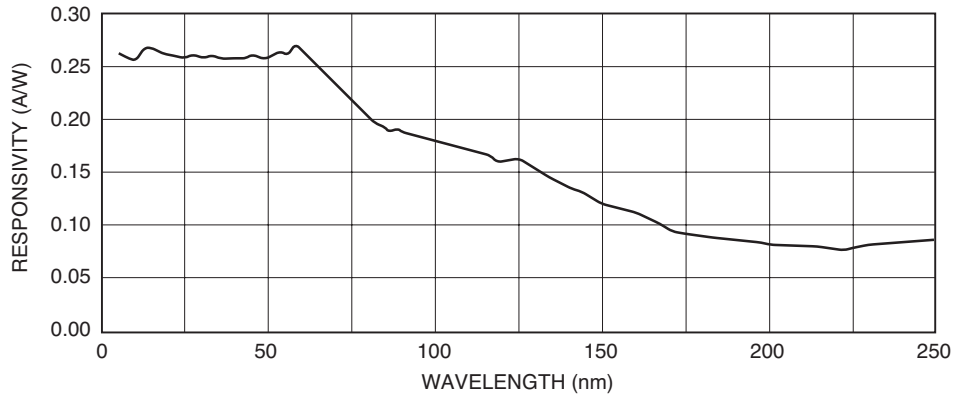

Typical UV-VIS-NIR Photon Responsivity

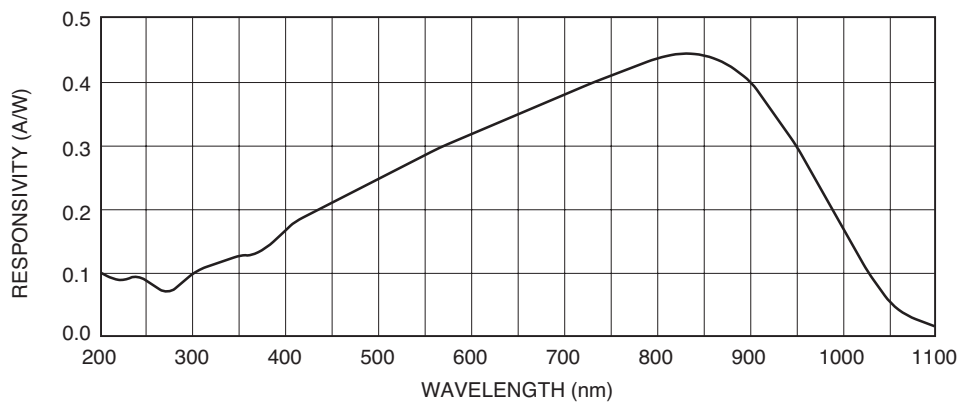

Capacitance vs. Voltage

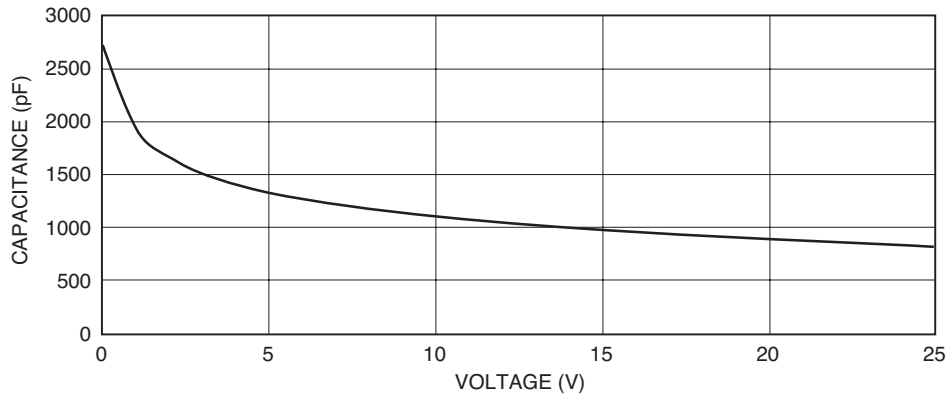

Dark Current vs. Voltage

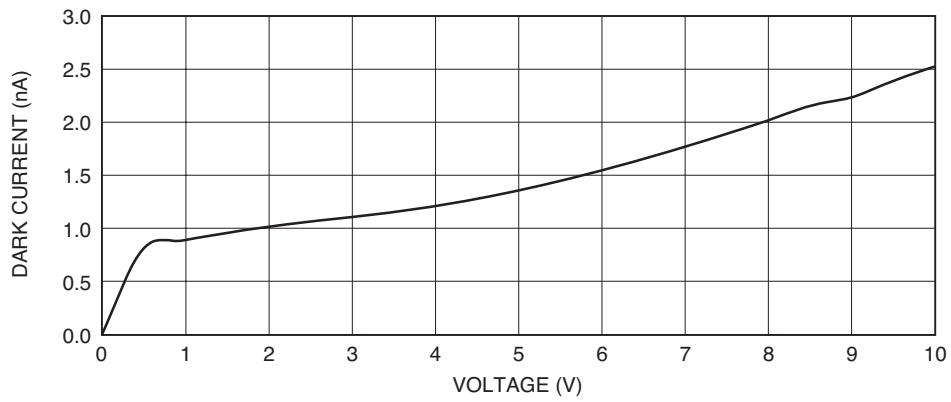

Package Information

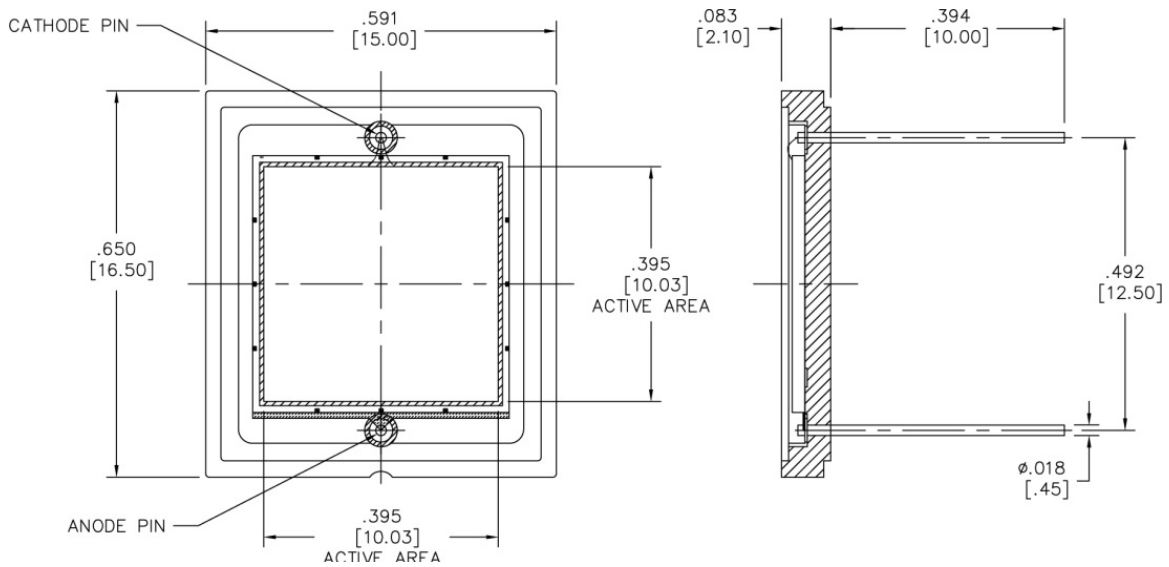

Dimensions are in inch [metric] units.

Specifications are subject to change without prior notice.